

werzalit®

since 1923.



FURNITURE

SUMMARY

07	IPAN IPAN INNOVATION
12	CLASSIC: TOP 20/TOP 50
16	BISTRO
18	POD
20	EASY PERSO
21	PERSO
23	CARINO
27	CAMBIUM & MASSIVE
33	BASES
55	CHAIRS & ARMCHAIRS
65	KITS
71	POS
73	ECOLINE

THIS EDITION OF
OUR 2021 CATALOG
MARKS A NEW STAGE
IN THE LIFE OF THE
WERZALIT® GROUP.

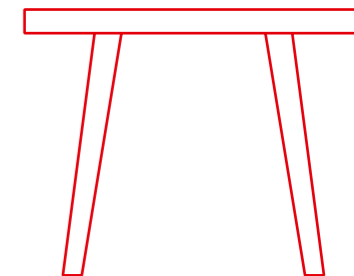

Being a key actor in the manufacture of moulded laminate tabletops for more than 60 years is a constant adaptation: **our** ambition is to constantly meet **your** needs.

By adapting the original Werzalit products, we go even further in **our** support by **your** side. To assert our role as a quality partner, our technical teams are constantly on the lookout for innovations. **We are** delighted to be able to **offer you**:

- hygienic tabletops, on which 99.7% of bacteria are eliminated after a simple cleaning with water and soap.
- eco-responsible tabletops, made with the greatest respect for nature and 100% from recycled wood.

The professionalism of the Werzalit group also means offering you complete solutions, made in France, with:

- a Top 20 and Top 50 with permanent stocks and fast delivery.
- technological innovations such as the Ipan Ipan phone charging area or the NoRock self-stabilizing table bases.

Our responsibility at Werzalit is not only sanitary, sustainable or innovative, it is also aesthetic: **our** range is expanding with the arrival of "massive" indoor tabletops which offer a unique charm and a refined style to **your** rooms.

Friends restaurateurs, cafetiers, brewers, **we are** and will remain wholeheartedly **with you**, and more than ever in these troubled sanitary times, **we are** proud to work **alongside you**.

Pascal Schuster
President

THE ORIGINAL

SERVICES

werzalit®
since 1923.

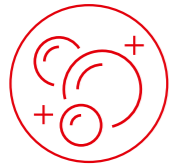

HYGIENIC

Our tabletops have been subject to do numerous **laboratory tests**, the results have shown **excellent resistance to fungi and bacteria**. Thanks to our material, more than **99.7%** of bacteria is eliminated after a simple cleaning with soapy water, which allows **easy maintenance** and **safe use**.



FRENCH PRODUCTION

The quality of French production, widely recognized, based on our **know-how**, has enabled Werzalit to offer the highest quality products on the market since 1923.

The thoroughness and quality of the work of our **employees** at the **production site** located in Rochefort (17) allow us to produce and deliver **throughout Europe** and **the world** at **any time of the year**.



ENVIRONMENTALLY FRIENDLY

The **choice of materials** and the **manufacturing process** comes with the **greatest respect for nature**. Our products are made from **100% recycled wood**. We optimize waste from the wood industry.

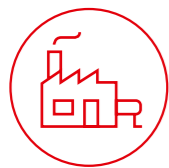

INDUSTRIAL

Our capability as an industrial key player in the market since 1923 allow us to display **recognized production quality** as well as **exemplary local service**. Our tabletops are **guaranteed for five years**, **waterproof** and **UV resistant**. Ideal for indoor and outdoor use.

TOP 20/50

Our selection of decors adapts to your needs, from a **choice of 8 formats and 50 decors** for **multiple possibilities** and warm atmospheres. As a manufacturer these 400 possibilities are kept in stock to better anticipate the needs of restaurateurs throughout the year.

Maintaining a good stock level is Werzalit key to efficient delivery.

For the bare tabletops:

THE TOP 20

is available for shipment within five days maximum.

THE TOP 50

is available for shipment within fifteen days maximum.

INSERT APPLY

By **4** or by **8**

The application of inserts greatly facilitates the assembly of tables and saves considerable time during installation.

PACKAGING ADAPTED TO YOUR NEEDS

- Per carton containing two products
- Per carton containing one product
- By full palette

BISTRO

The first manufacturer to bring you the tradition of Ø 60, Ø 70 rimmed outdoor tabletops, we guarantee a quality to provide you with 55x55, 60x60 and 70x70 framed outdoor tabletops.

POD, THE CREATION

Werzalit, the **French manufacturer**, is always one step ahead with **innovative creative lines** and **consistently updating on demand products**.

In addition to our existing library and as a true fashion designer, several themed collections will be offered during the year.

PICTOGRAPHY



Flap



NOROCK
Self-stabilizing

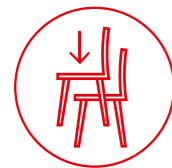

Stackable

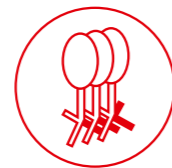

Storage

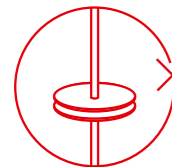

Do not stack



Natural aluminium
suitable for the
seaside

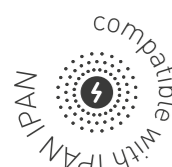

Compatible Ipan Ipan

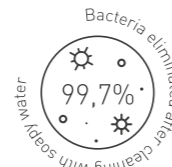

Antibacterial surface



Innovation

IPAN IPAN



Werzalit & Ipan Ipan have joined forces to offer you the best wireless charging solutions at the table!

Completely embedded into the substrate and invisible on the surface, the induction charging zone blends into the decor with a simple marking on the tabletop. The furniture thus retains its integrity for a perfectly smooth touch and a hygienic surface.



Outdoor & indoor



No power connection



4-battery charger



Locked batteries



Liquid resistant



Ready to use



8 days of autonomy



2 USB ports



1 wireless charging zone

About **50%** of consumers will be willing to stay longer or consume more if they can charge their devices.

64% of consumers want to charge their phone or tablet in the establishment they are.

IPANIPAN



werzalit®
since 1923.

TABLETOPS

Werzalit offers you a collection of designed and varied tabletops. High-quality and hygienic, our tabletops give your rooms and your terraces an authentic charm and a unique aesthetic.

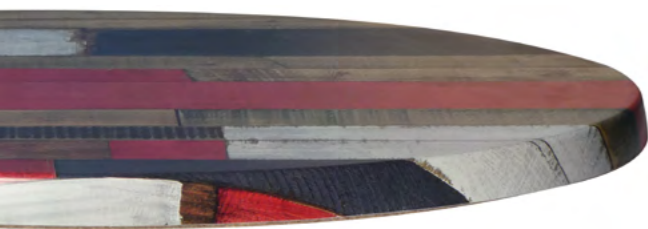

TOP 20/50

Moulded laminate tops.
Fixings by wooden screws or inserts.

P. 12 - 15



BISTRO

Moulded laminate tops with strapping and framing.
Framing available: brass, stainless steel, copper.
Fixings by wooden screws or inserts.

P. 16 - 17

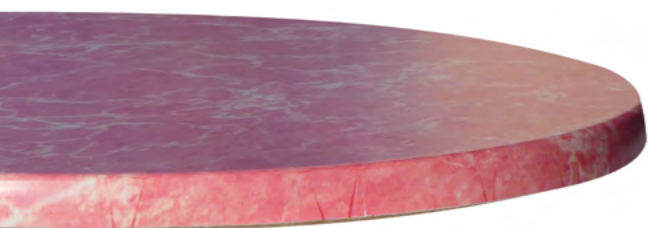

POD

Selection of creative and original
moulded laminate tops.
Fixings by wooden screws or inserts.

P. 18 - 19



EASY PERSO

Custom moulded laminate tops in a pre-defined
colour and finish set.
Fixings by wooden screws or inserts.

P. 20

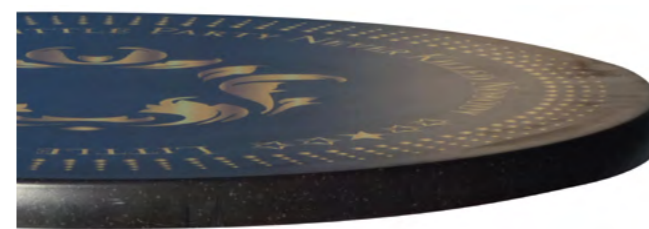

PERSO

Moulded laminate tops, fully personalized,
and adapted to your needs.
Fixings by wooden screws or inserts.

P. 21



CARINO

Compact HPL tops.
Fixings by grooves and special screws.

P. 22 - 25



CAMBIUM

Indoor wood-look laminate tops.
Fixings by wooden screws or inserts.

P. 26 - 29



MASSIVE

Solid oak tops.
Fixings by wood screws.

P. 26 - 29



Moulded laminate

TOP 20

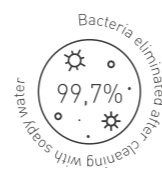
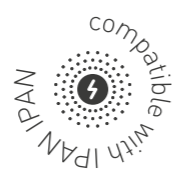

Your orders delivered in record time

Top 20 decors are kept in permanent stock in the eight formats specified below, the other formats are available on request.

For the delivery of the Top 20, Werzalit offers you an express and quality service. Expertise of our products and quick response time enables us greater flexibility to deliver quality products to you quickly. Order directly and have an order shipped in record time within five days.

○ ROUND			□ SQUARE			□ RECTANGLE		OTHER SIZES
Ø 60	Ø 70	Ø 80	60X60	70X70	80X80	110X70	120X80	on demand
•	•	•	•	•	•	•	•	

⚡ Decors compatible with Ipan Ipan

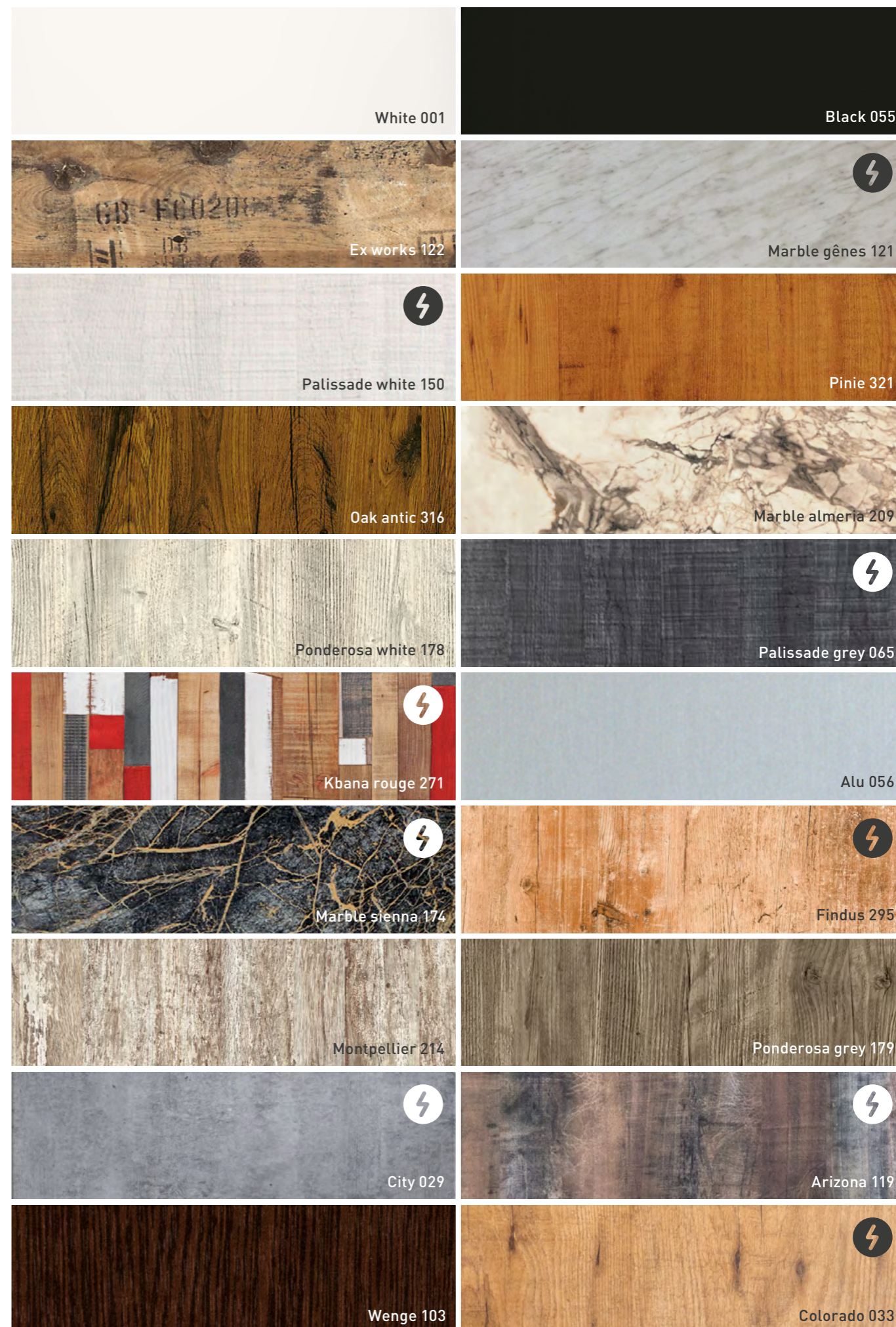



Moulded laminate

TOP 50

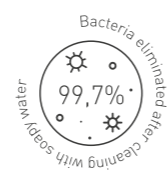
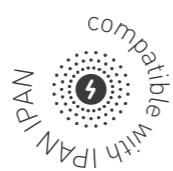

Your orders delivered in record time

Top 50 decors are kept in permanent stock in the eight formats specified below, the other formats are available on request.

Top 50, in addition to the Top 20, enjoy 30 additional decors with the guarantee of a fast and efficient delivery service. Choose from a selection of 30 decors. Order directly and have it shipped within 15 days.

○ ROUND			□ SQUARE			▭ RECTANGLE		OTHER SIZES
Ø 60	Ø 70	Ø 80	60X60	70X70	80X80	110X70	120X80	on demand
•	•	•	•	•	•	•	•	

⚡ Decors compatibles with Ipan Ipan

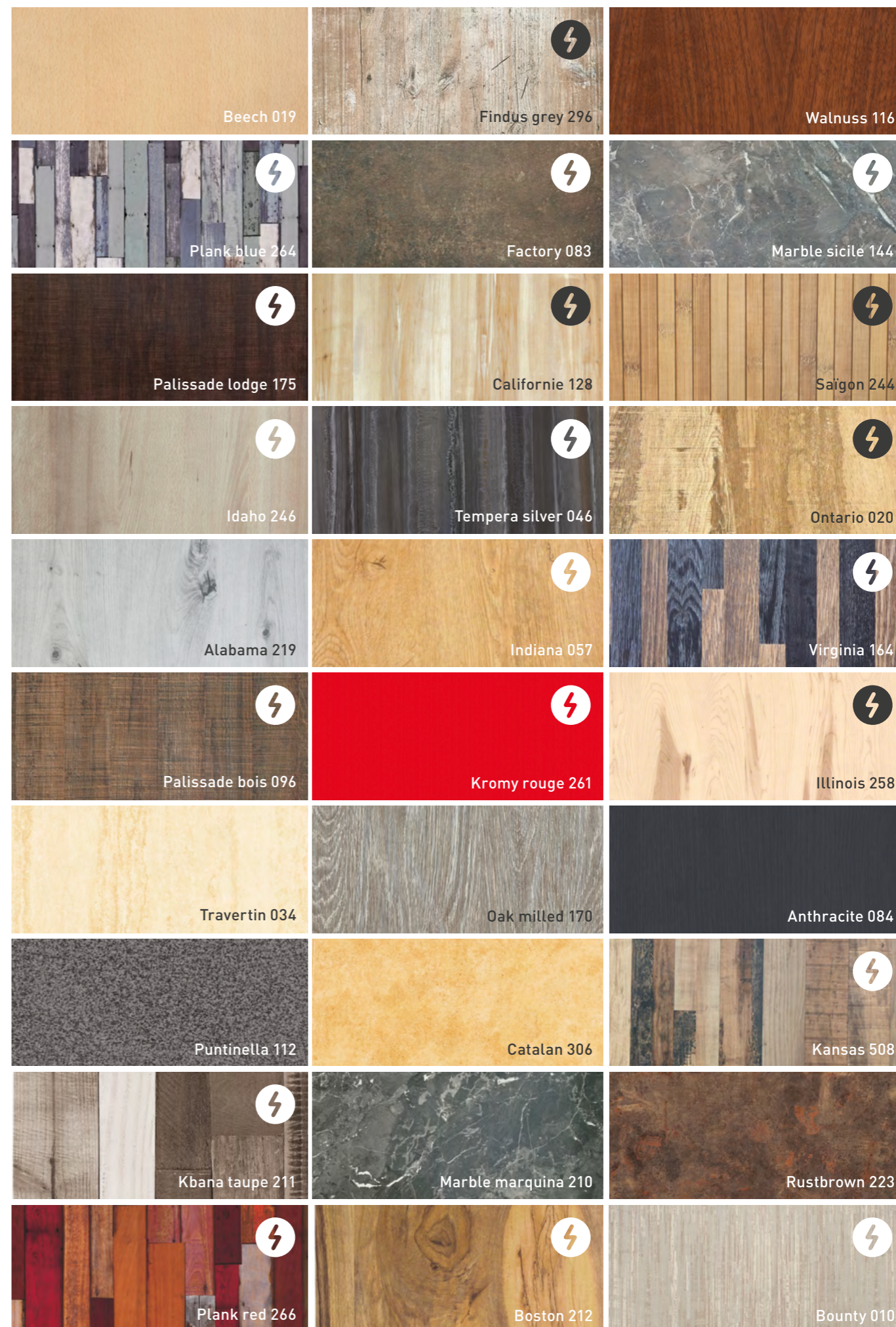

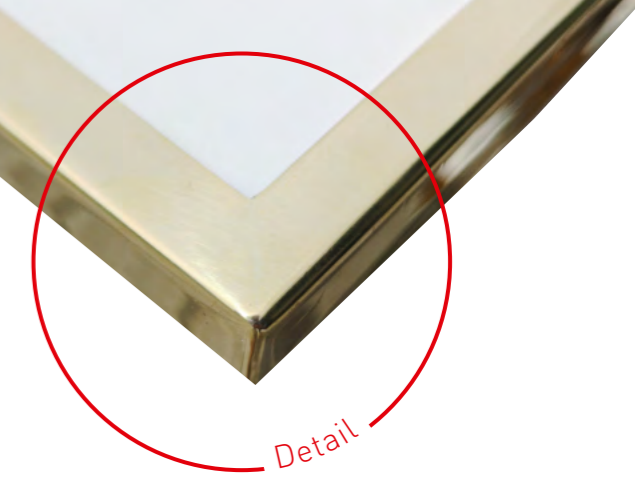

The Bistro finish is available on:

- All the decors of the Classic range
- All the creations of the POD range
- Your EASY PERSO and PERSO creation projects
- All the colours of the Bistro Macaron range
- Massive range
- Finishes: brass, stainless steel and copper

It is with the knowledge and know-how of our employees, that we have been able to develop a mastery of the framing technique for outdoor tabletops giving the product an elegant and refined aesthetic. This is the result of high-quality and rigorous manufacturing know-how.

Werzalit is the first to offer you an outdoor quality framed solution.



Marble marquina
Stainless steel ring
Ø 60



Vichy rouge
Stainless steel ring
Ø 60

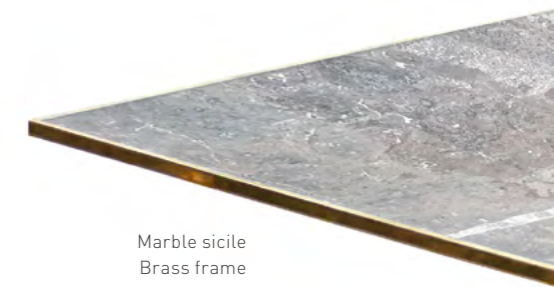

Marble sicile
Brass frame
55x55

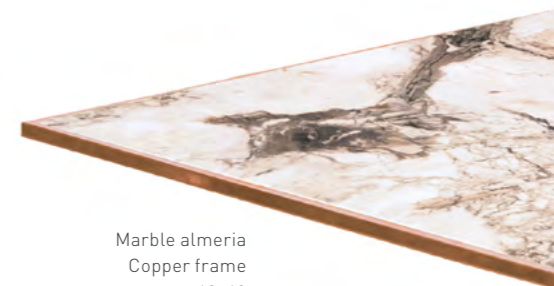

Marble almeria
Copper frame
60x60

BISTRO

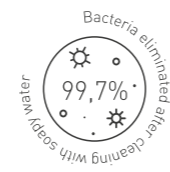

With this collection, discover the elegance and authenticity of a true Parisian bistro, and create warm and traditional ambience for your restaurant. Our Bistro finish is available on the Top 20 /50 selection, in POD as well as for Perso creations. It is also compatible with our Ipan Ipan charging technology. Do not wait any longer to experience Parisian style. New addition this year, you can frame solid wooden tops in 70x70.



Marble sienna Ø 70
Brass rim
Bistro base 3



Blue macaron 70x70
Brass frame
Bistro base 4

○ ROUND		□ SQUARE		
Ø 60	Ø 70	55X55	60X60	70X70
•	•	•	•	•



POD

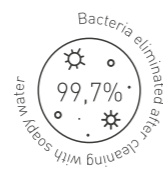

Product on demand

Our Products On Demand are THE creative and original solution constantly renewed by us. The great diversity of decors allows you to stand out from your competitors and create a real personality for your establishment. Find the complete collection available on www.werzalit.com.

Consult the rest of the POD range via our website:
www.werzalit.com

Consult us for the available formats.

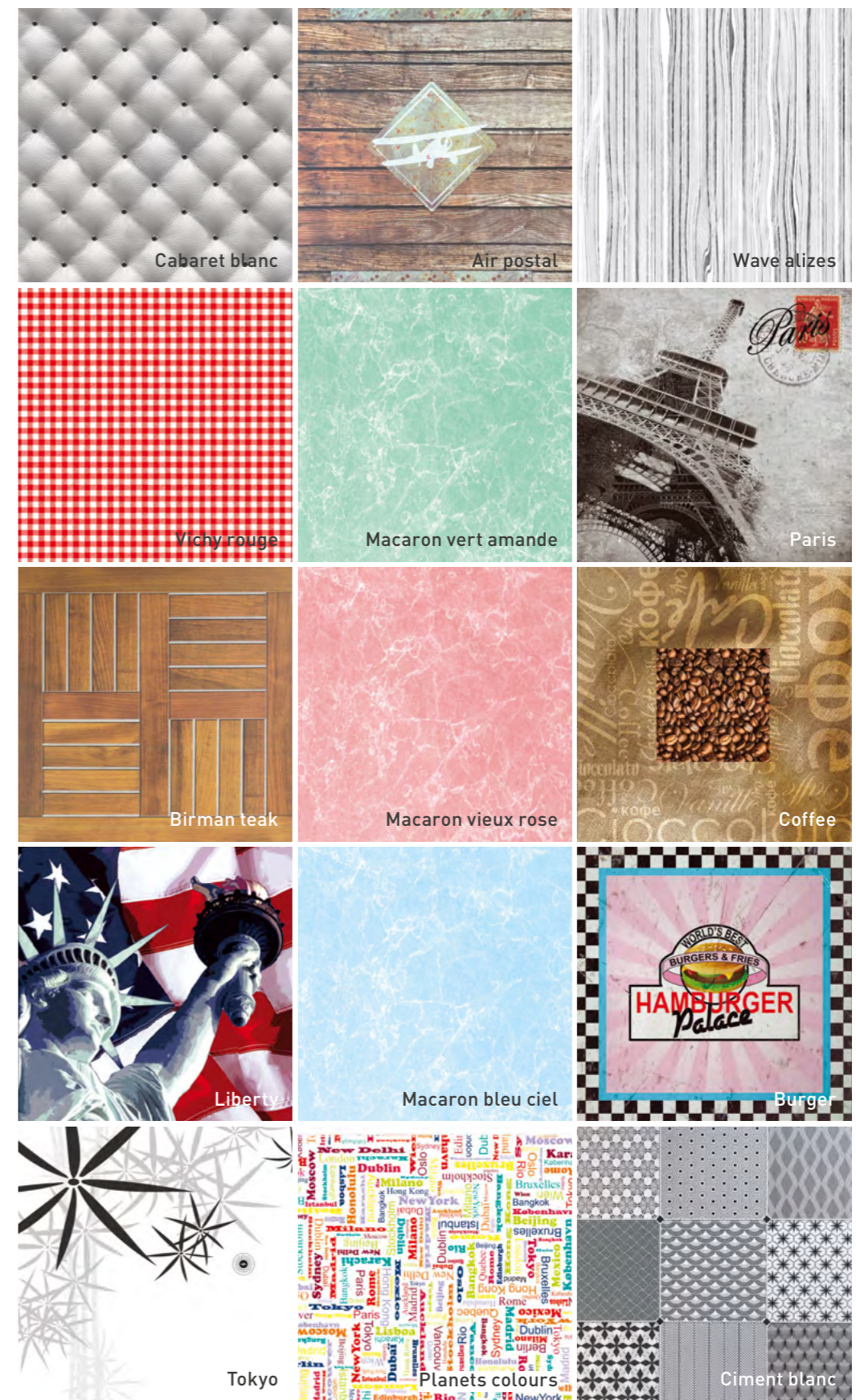

EASY PERSO

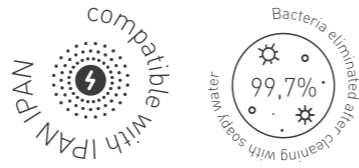

The EASY PERSO tabletop is made to measure in accordance with your request

The Easy Perso tabletop allows you to **easily and quickly** create a tabletop **that suits you**.
Play with our **4 finishes and our 16 colours for more than 60 possibilities**, add your logo and voilà.
Logo with minimum 300 dpi resolution & 1:1 scale to provide.

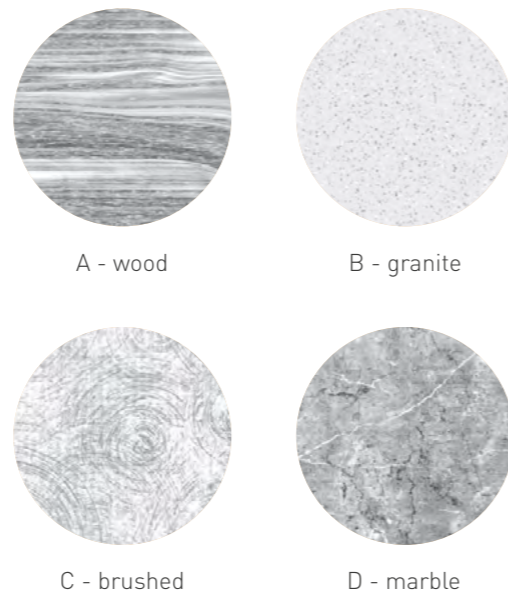
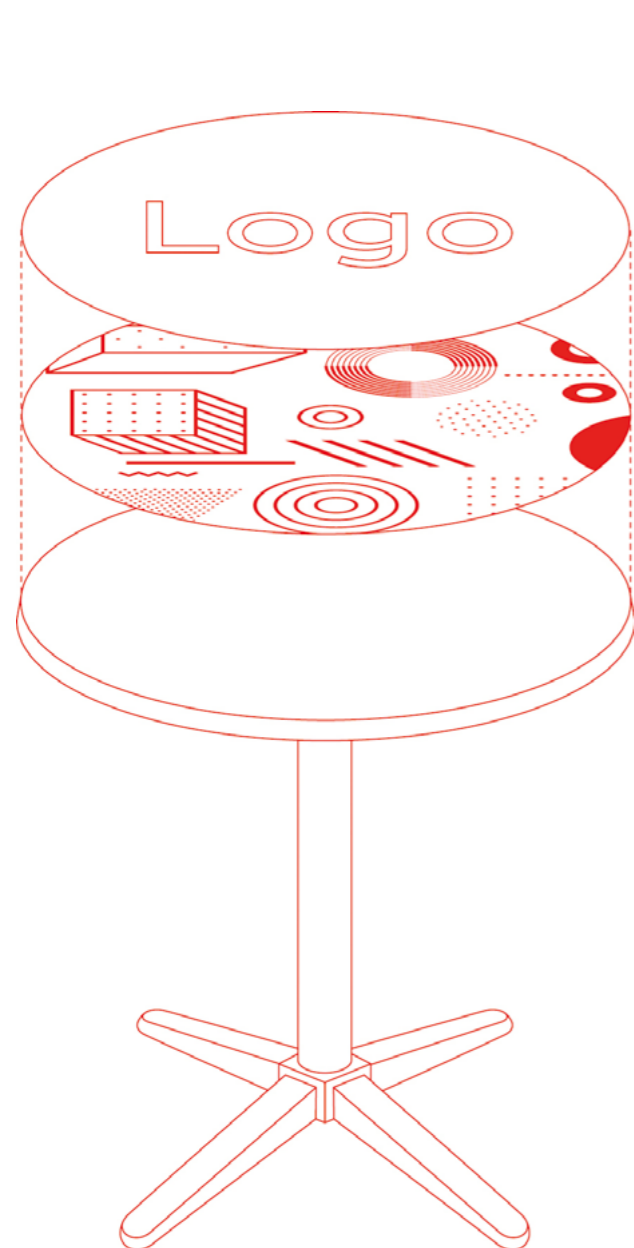

PERSO



Make a **tailor-made** tabletop according to your wishes, choose the shape (round, square or rectangle), the size, send us **your logo** in **minimum 300 DPI resolution** and we will take care of creating your **personalized support**.

To send us

Provide us with your logo in 300 dpi and we will create tabletops in the image of your business. Digital file (eps, ai, pdf, psd, jpg)
- Resolution 300 dpi minimum & scale 1:1 - Conditions: see technical costs and current prices.





werzalit®
since 1923.

Indoor & Outdoor

CARINO

The Carino tabletop is the elegant and functional product of the solutions offered by Werzalit. This standard collection offers a wide variety of designs for terraces with character, while meeting the quality and price expectations of professionals. These tabletops are customizable and UV resistant.

3 edge shapes

slope rounded straight

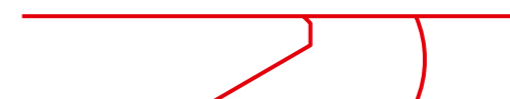

10 - 12 mm thick. Original size.

Compact HPL

CARINO



Carino tabletops are customizable

The Carino collection, in addition to its remarkable aesthetic appearance, is UV resistant and can be used outdoors. It is compatible with the decorations of the Top 20.

Finitions



Fixing solutions

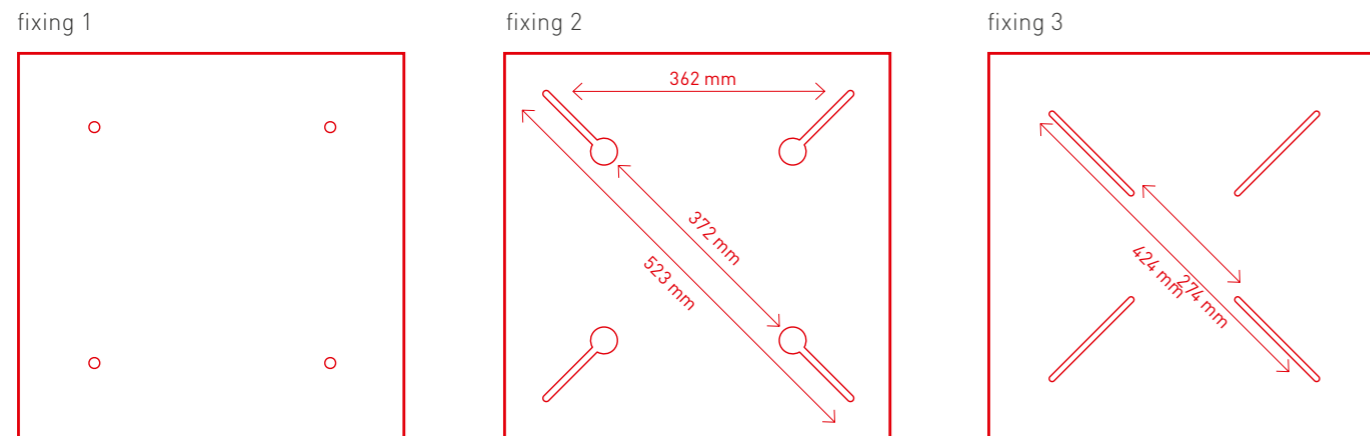

Installation of inserts for M6 screws.

The secure mounting system using grooves milled on one side allows the tops to be fixed to all conventional bases without drilling. Groove length 200 mm. Special screws.

The Eco fixing system consists of a 3.5 mm wide rain, in which we fix the bases using special 6x12 screws. Screws included.

○ ROUND				□ SQUARE					▭ RECTANGLE						OTHER SIZES		
Ø 60	Ø 70	Ø 80	Ø 90	50x50	60x60	70x70	80x80	90x90	70x60	100x60	110x70	120x80	140x70	140x80	160x80	160x90	on demand
•	•	•	•	•	•	•	•	•	•	•	•	•	•	•	•	•	

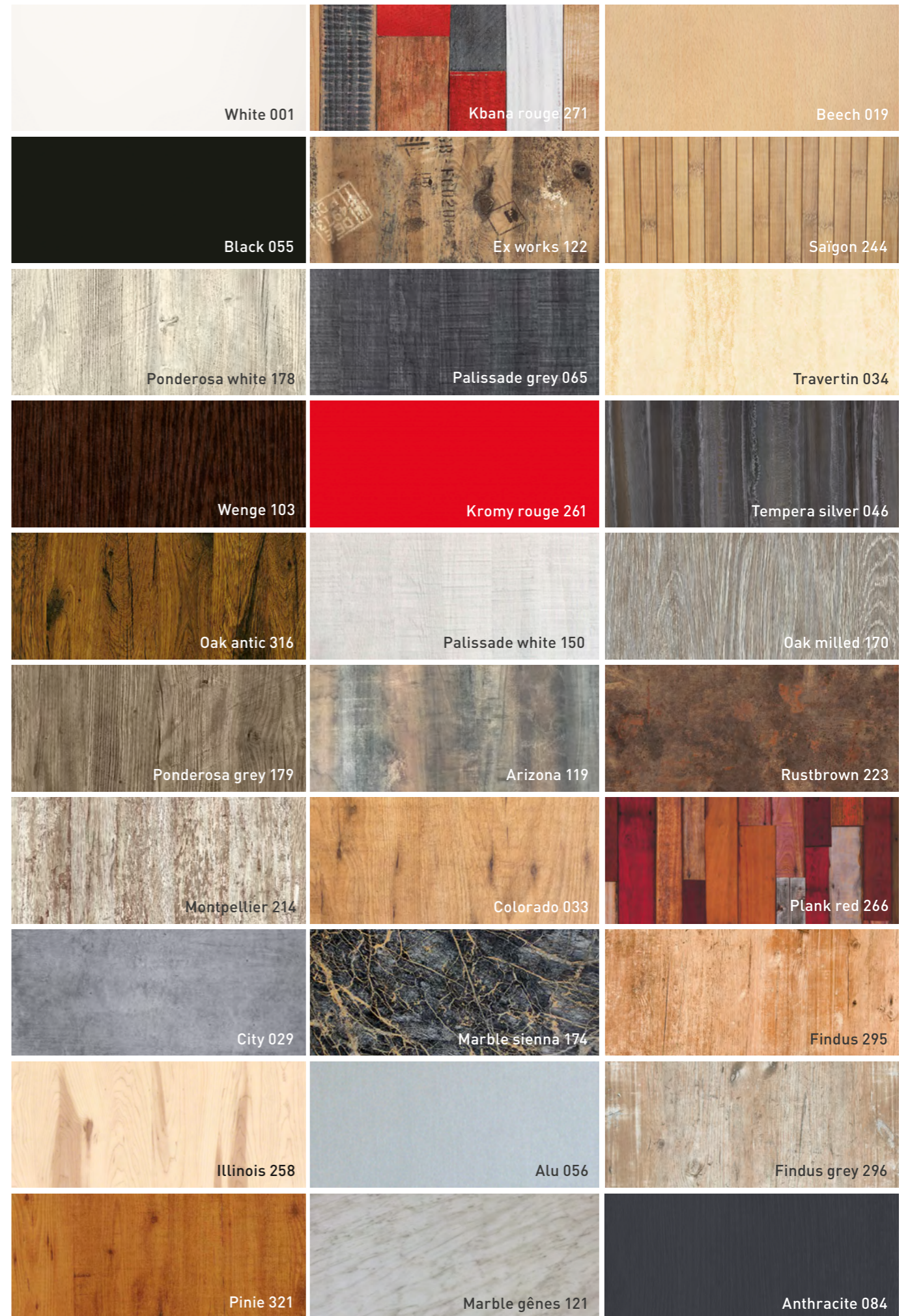



Indoor CAMBIUM

Werzalit has designed a whole new collection of indoor tabletops to meet your expectations. With this elegant and aesthetic collection, you can find warm and intimate atmospheres in your business.

- Laminated surface 7/10th
- Water-repellent chipboard core
- Steamed paper underside for 29 to 30 mm tabletops
- White 7/10th statified underside for 21 mm tops

3 edge shapes

21 - 29 - 39 mm thick.

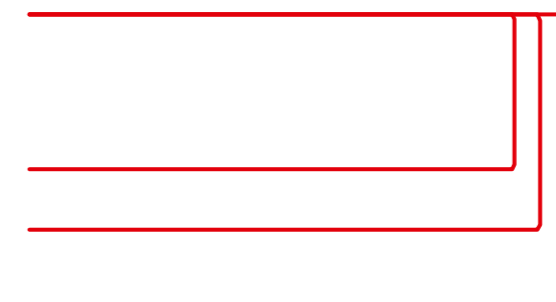

Indoor MASSIVE

The novelty of Werzalit for your indoor, thanks to the authentic charm of these real solid oak tops, make your rooms a friendly and essential place while keeping a refined design line.

- Oak aged two years

22 mm thick.



Cambium Indoor
CLASSIC



This collection of indoor furniture has been designed with sobriety by Werzalit. The choice of materials and colours is made for design and elegance. A collection which gives a singular character to bars, restaurants and hotels.

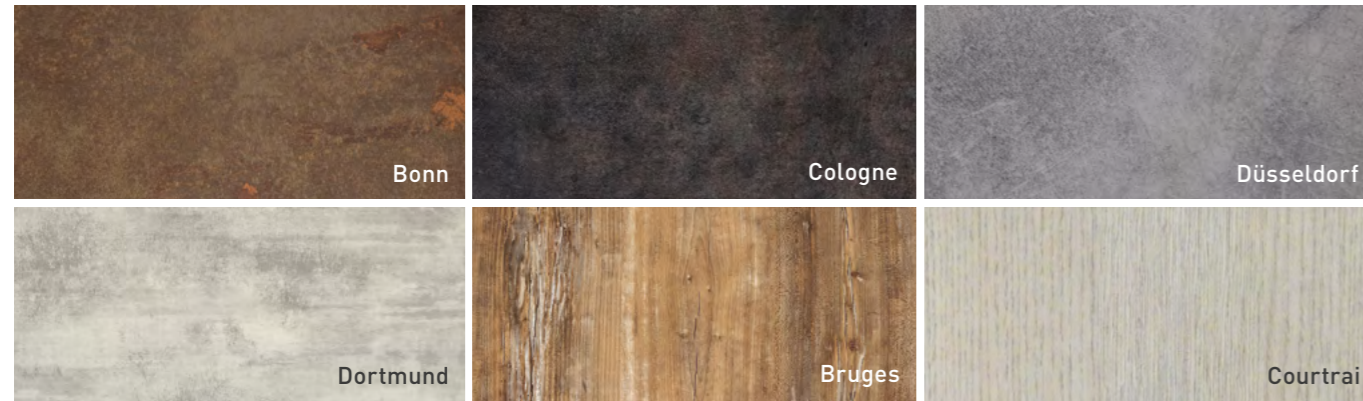

○ ROUND	□ SQUARE			□ RECTANGLE	
Ø 60	60X60	70X70	80X80	70X60	120X70
•	•	•	•	•	•



Indoor
MASSIVE

The new collection of solid wood indoor tops from Werzalit. Enjoy the durability and elegance of real solid wood in your business or restaurant. Through these tops you will find the aesthetics and the inimitable authenticity of the solid oak that your indoor needs.

Cambium Indoor
SYNCHRO

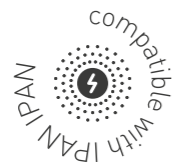

The realism of the wood grain ribs and Halifax oak knots are eye-catching, while creating the most authentic decor in line with the furniture trend with solid wood character. It lives very well in combination with metal, glass and stone. The ST37 Feelwood Rift synchronized pore surface structure coincides exactly with the grain of the decor and adds a tactile effect close to reality.



○ ROUND	□ SQUARE		□ RECTANGLE	
Ø 60	65X65	80X80	70X60	120X70
•	•	•	•	•

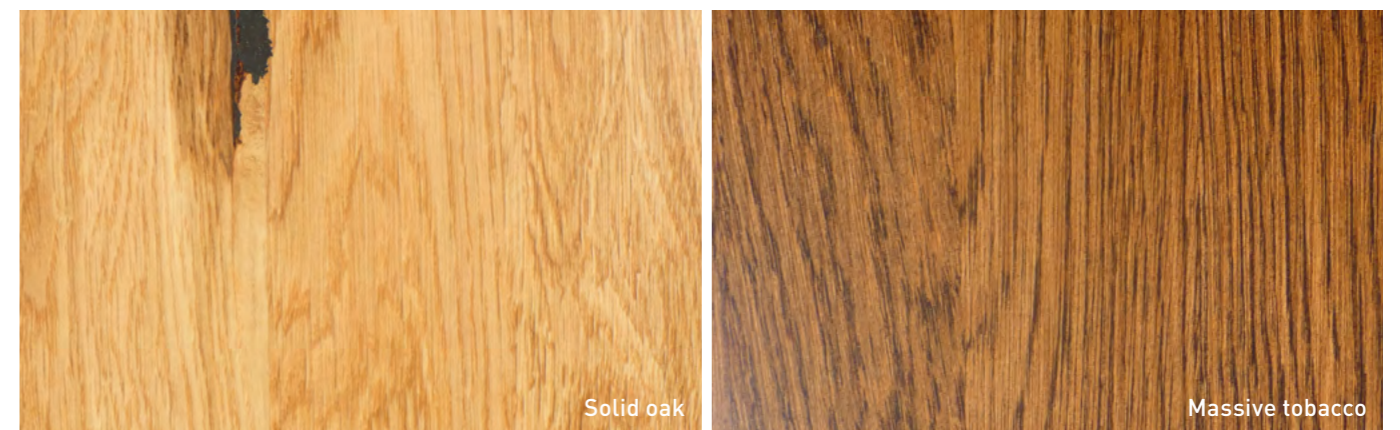

○ ROUND			□ SQUARE		□ RECTANGLE	
Ø 60	Ø 70	Ø 115	60X60	70X70	70X60	115X70
•	•	•	•	•	•	•

Indoor

CAMBIUM

FORM	CIRCLED / FRAMED	IPAN IPAN	SIZES	THICKNESS	EDGE SHAPE	WEIGHT
○		⚡	∅ 60 cm	21 - 29 - 39 mm		4,7 kg
			60 x 60 cm	21 - 29 - 39 mm		4,2 kg
□		⚡	65 x 65 cm	21 - 29 - 39 mm		5,9 kg
			70 x 70 cm	21 - 29 - 39 mm		8,3 kg
			80 x 80 cm	21 - 29 - 39 mm		10,8 kg
▭		⚡	70 x 60 cm	21 - 29 - 39 mm		7 kg
			120 x 70 cm	21 - 29 - 39 mm		9,9 kg

Indoor

MASSIVE

FORM	CIRCLED / FRAMED	IPAN IPAN	SIZES	THICKNESS	EDGE SHAPE	WEIGHT
○			∅ 60 cm	22 mm		10,2 kg
			∅ 70 cm	22 mm		11,9 kg
			∅ 115 cm	22 mm		19,6 kg
□			60 x 60 cm	22 mm		7,9 kg
			70 x 70 cm	22 mm		10,7 kg
▭			70 x 60 cm	22 mm		9,2 kg
			115 x 70 cm	22 mm		15 kg

Indoor & Outdoor

CARINO

FORM	CIRCLED / FRAMED	IPAN IPAN	SIZES	THICKNESS	EDGE SHAPE	WEIGHT
○			∅ 60 cm	10 - 12 mm		4,7 kg
			∅ 70 cm	10 - 12 mm		6,5 kg
			∅ 80 cm	10 - 12 mm		8,4 kg
			∅ 90 cm	10 - 12 mm		10,6 kg
□			50 x 50 cm	10 - 12 mm		4,2 kg
			60 x 60 cm	10 - 12 mm		5,9 kg
			70 x 70 cm	10 - 12 mm		8,3 kg
			80 x 80 cm	10 - 12 mm		10,8 kg
			90 x 90 cm	10 - 12 mm		13,5 kg
			70 x 60 cm	10 - 12 mm		7 kg
▭			100 x 60 cm	10 - 12 mm		9,9 kg
			110 x 70 cm	10 - 12 mm		12,8 kg
			120 x 80 cm	10 - 12 mm		16 kg
			140 x 70 cm	10 - 12 mm		16,3 kg
			140 x 80 cm	10 - 12 mm		18,6 kg
			160 x 80 cm	10 - 12 mm		21,3 kg
			160 x 90 cm	10 - 12 mm		23,9 kg

TOP 20/50, POD, EASY PERSO, PERSO

FORM	CIRCLED / FRAMED	IPAN IPAN	SIZES	THICKNESS	EDGE SHAPE	WEIGHT	PACKAGING			
○		⚡	∅ 40 cm	26 mm	17 mm	-	330			
			∅ 60 cm	26 mm	17 mm	4,3 kg	100			
			∅ 70 cm	26 mm	17 mm	5,7 kg	80			
			∅ 80 cm	26 mm	17 mm	6,9 kg	80			
			∅ 90 cm	26 mm	17 mm	9 kg	70			
			∅ 100 cm	26 mm	17 mm	10,8 kg	70			
			∅ 105 cm	35 mm	16 mm	12,5kg	70			
			∅ 120 cm	35 mm	17 mm	16 kg	70			
			□		⚡	55 x 55 cm	35 mm	18 mm	4,8 kg	-
						60 x 60 cm	35 mm	18 mm	5,7 kg	100
70 x 70 cm	35 mm	19 mm				8,4 kg	50			
80 x 80 cm	35 mm	19 mm				11 kg	50			
90 x 90 cm	35 mm	19 mm				13,6 kg	50			
70 x 60 cm	35 mm	18 mm				6,9 kg	50			
▭			80 x 60 cm	35 mm	19 mm	8 kg	50			
			100 x 60 cm	35 mm	20 mm	10,5 kg	50			
			110 x 70 cm	35 mm	19 mm	11,3 kg	50			
			120 x 80 cm	35 mm	19 mm	15,5 kg	50			

TECHNICAL CHARACTERISTICS

Advantage

- A complete range.
- Recognized professional use.
- A design that makes the difference.
- Over 99.7% of bacteria are eliminated with a simple cleaning with soapy water.

- Robust and stable.
- Resistance to bad weather, heat.
- Excellent resistance to humidity.
- Indoor and outdoor use.

MAINTENANCE

Alcohol based solvent
 No abrasive
 Storage
 Do not stack

WARNING

When tabletops are to remain in bright sunshine, it is advisable to select light colours.
 Si les plateaux doivent être soumis à un violent ensoleillement, il est préférable de choisir des décors clairs.



TABLE BASES

Werzalit brings you a complete and innovative selection of high-quality and functional bases. Our table bases will allow you to comfortably host your customers while being practical to store or move.

T-BASE



self-stabilizing

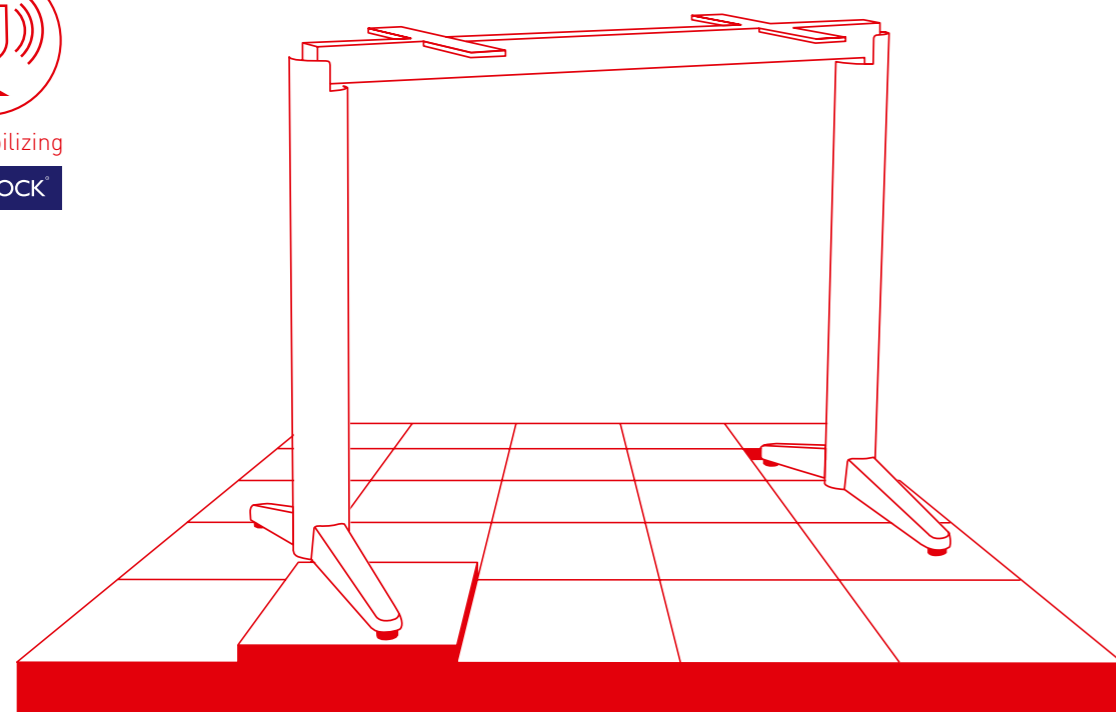

In continuity from the CONTACT X4 solutions, the T-BASE is THE complementary solution for the perfect stability of your rectangular tables:

- It absorbs the imperfections of the ground without any action of your part
- The T-BASE is available in Trail and Street version (page 38)

LUNA



self-stabilizing

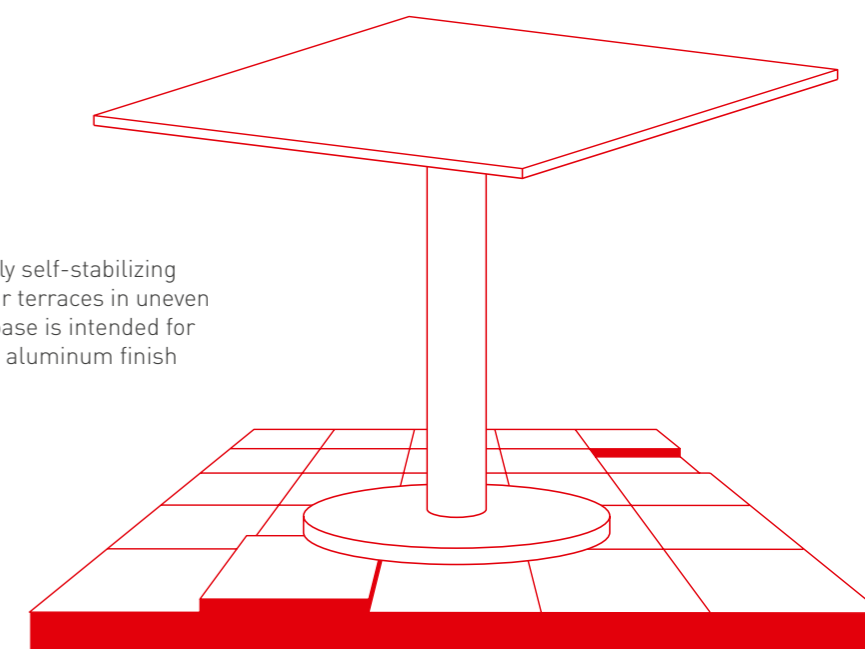

Werzalit introduces its Luna innovation, the only self-stabilizing plinth table base. It will allow you to set up your terraces in uneven places without risking losing aesthetics. This base is intended for both indoor and outdoor use, its black painted aluminum finish gives it a simple and refined design.

	WIDTH	LENGTH	HEIGHT	WEIGHT	MAX SIZE
T-BASE	50 cm	91,5 cm	71,5 cm	13,6 kg	120x80 cm

Innovation

CONTACT X4

The self-stabilizing base

Thanks to patented technology, the CONTACT X4 self-stabilizing base adapts to any irregular surface: cobbled street, gravel, grass, clay.

Simply put the table down and the legs adjust to the floor.

- Indispensable comfort for consumers.
- Time saving for you, professionals.

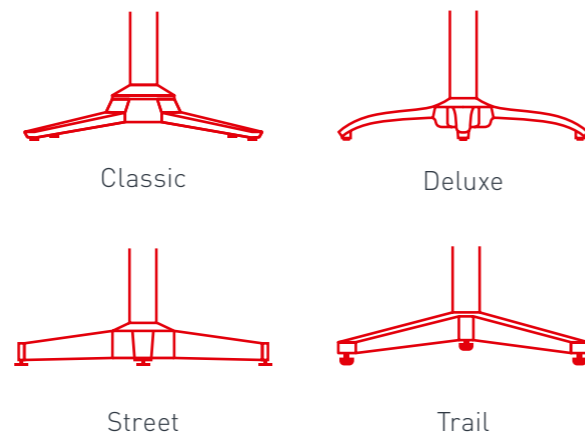

CONTACT X4 / DELUXE

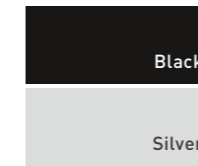

self-stabilizing



flap

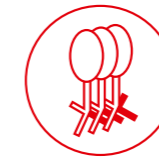

storage



CONTACT X4 DELUXE SILVER

CONTACT X4 / CLASSIC

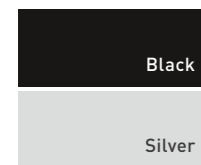

self-stabilizing



CONTACT X4 CLASSIC SILVER

	WIDTH	LENGTH	HEIGHT	WEIGHT	MAX SIZE
CLASSIC	47 cm	51,1 cm	71 cm	4,7 kg	Ø 80 ; 80x80 ; 70x60 cm
CLASSIC MD			110 cm	5,4 kg	Ø 70 ; 70x70 ; 70x60 cm

CONTACT X4 / LUNA



Pure design with essential features. These are the promises of the CONTACT X4 Luna. First self-stabilizing plinth base with 20mm adjustability to compensate for uneven surfaces.



self-stabilizing



CONTACT X4 LUNA BLACK

	WIDTH	LENGTH	HEIGHT	WEIGHT	MAX SIZE
LUNA	Ø 53 cm		71 cm	14,5 kg	Ø 80 ; 80x80
DELUXE	47 cm	51,5 cm	71 cm	5,4 kg	Ø 80 ; 80x80 ; 70x60 cm
DELUXE MD			110 cm	6,1 kg	Ø 70 ; 70x70 ; 70x60 cm

CONTACT X4 / TRAIL

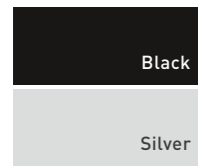

self-stabilizing



T-BASE TRAIL SILVER



CONTACT X4 TRAIL BLACK

CONTACT X4 / STREET

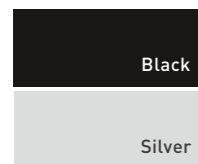

self-stabilizing



T-BASE STREET BLACK



CONTACT X4 STREET BLACK

	WIDTH	LENGTH	HEIGHT	WEIGHT	MAX SIZE
X4 TRAIL	46 cm	46 cm	71 cm	6 kg	Ø 80 ; 80x80 cm
X4 TRAIL MD			110 cm	7,3 kg	Ø 70 ; 70x70 cm
T-BASE	50 cm	91,5 cm	71,5 cm	13,6 kg	120x80 cm
X4 STREET	46 cm	46 cm	71 cm	7,2 kg	Ø 80 ; 80x80 cm
X4 STREET MD			110 cm	8,4 kg	Ø 70 ; 70x70 cm
T-BASE	50 cm	91,5 cm	71,5 cm	13,6 kg	120x80 cm

BISTRO

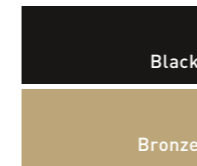

The range of Bistro bases comes from the pure French tradition. THE typical model of Parisian terraces.



flap



BISTRO 3 FLAP BLACK



BISTRO 4 MD BLACK



BISTRO 3 BRONZE*



BISTRO LATERAL PM BLACK



BISTRO 4

	WIDTH	LENGTH	HEIGHT	WEIGHT	MAX SIZE
BISTRO	46 cm	41 cm	71,5 cm	12,4 kg	Ø 60 cm
BISTRO 3 FLAP				6,5 kg	
BISTRO 4	39 cm	39 cm	108 cm	13,6 kg	Ø 70 ; 70x70 cm ; 70x60 cm
BISTRO 4 MD				17,2 kg	Ø 70 ; 60x60 cm
BISTRO LATERAL PM	39 cm	51 cm	71,5 cm	12 kg	80x80 cm ; 80x60 cm
BISTRO LATERAL GM		81 cm		12,6 kg	Ø 70 ; 70x70 cm

*Bronze colour, Bistro 3 only

NICE

Black



NICE BLACK

RONDA

Black



RONDA 55 MD BLACK



RONDA 42 TB BLACK



RONDA 55 BLACK

VÉSUVÉ

Black



VÉSUVÉ ROUND BLACK



VÉSUVÉ SQUARE BLACK



VÉSUVÉ RECTANGLE BLACK



VÉSUVÉ ROUND MD BLACK

	WIDTH	LENGTH	HEIGHT	WEIGHT	MAX SIZE
RONDA 42 TB	Ø 42 cm		42,5 cm	14 kg	Ø 80 ; 80x80 ; 80x60 cm
RONDA 42			72 cm		
RONDA 42 MD			108 cm		
RONDA 55	Ø 55 cm		72 cm	23 kg	Ø 120 ; 90x90 ; 110x70 cm
RONDA 55 MD			108 cm	24 kg	Ø 90 ; 80x80 cm
NICE	40 cm	40 cm	73 cm	11,3 kg	Ø 70 ; 70x70 ; 70x60 cm

	WIDTH	LENGTH	HEIGHT	WEIGHT	MAX SIZE
VÉSUVÉ SQUARE	43 cm	43 cm	72 cm	16 kg	Ø 80 ; 80x80 ; 80x60 cm
VÉSUVÉ SQUARE MD			108 cm	16,5 kg	Ø 70 ; 70x70 ; 70x60 cm
VÉSUVÉ ROUND	Ø 43 cm		72 cm	15 kg	Ø 80 ; 80x80 cm
VÉSUVÉ ROUND MD			108 cm	15,5 kg	Ø 70 ; 70x70 ; 70x60 cm
VÉSUVÉ RECTANGLE	40 cm	55 cm	73 cm	19,3 kg	120x80 cm

AVANGARD

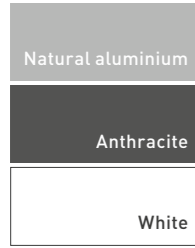

natural aluminium suitable for the seaside



flap

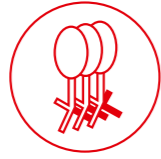

storage



AVANGARD FLAP NATURAL ALU



AVANGARD FIXED NATURAL ALU



AVANGARD FLAP MD NATURAL ALU

	WIDTH	LENGTH	HEIGHT	WEIGHT	MAX SIZE
AVANGARD FIXED	47 cm	51,5 cm	71 cm	6,5 kg	Ø 80 ; 80x80 ; 70x60 cm
AVANGARD FLAP					
AVANGARD FLAP MD			111,5 cm	8 kg	Ø 80 ; 70x60 cm

BOOMRANG



flap

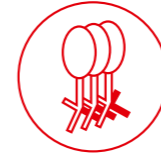

storage



BOOMRANG FLAP SILVER



BOOMRANG FLAP ANTHRACITE

REFLEX

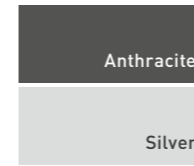

flap

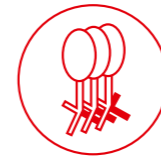

storage



REFLEX 3 FLAP ANTHRACITE



REFLEX 3 FLAP SILVER

	WIDTH	LENGTH	HEIGHT	WEIGHT	MAX SIZE
BOOMRANG FLAP	51,5 cm	51,5 cm	71 cm	5 kg	Ø 90 ; 90x90 cm
BOOMRANG FLAP MD			111,5 cm	6,6 kg	Ø 80 ; 80x80 cm
REFLEX 3 FLAP	52 cm	52 cm	72 cm	9 kg	Ø 70

TYA

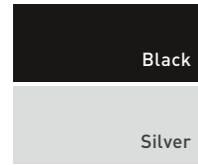

TYA 4 SILVER

AVE

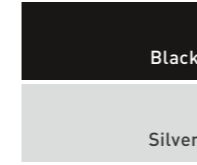

AVE 4 FLAP BLACK



TYA LATERAL FLAP BLACK



TYA 4 FLAP BLACK



TYA MD FLAP BLACK



AVE LATERAL FLAP SILVER



AVE 4 MD FLAP BLACK

	WIDTH	LENGTH	HEIGHT	WEIGHT	MAX SIZE
TYA 4	46 cm	46 cm	71 cm	2,4 kg	Ø 70 ; 70x70 cm
TYA 4 FLAP				2,8 kg	
TYA MD			114 cm	2,7 kg	
TYA MD FLAP				3,1 kg	
TYA LATERAL	62 cm	72 cm	71 cm	3,6 kg	110x70 ; 120x80 cm
TYA LATERAL FLAP				4,4 kg	

	WIDTH	LENGTH	HEIGHT	WEIGHT	MAX SIZE
AVE 4 FLAP	52 cm	52 cm	72 cm	6,2 kg	Ø 80 ; 80x80 ; 80x60 cm
AVE 4 MD FLAP			110 cm	6,9 kg	
AVE LATERALFLAP		95 cm	72 cm	9,5 kg	

RAINBOW

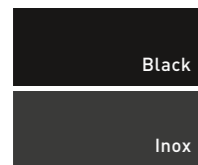

RAINBOW FLAP LATERAL INOX

RAINBOW FLAP MD BLACK

RAINBOW FLAP INOX

EROS

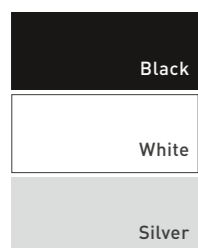

EROS 80X80 WHITE



EROS 80X80 SILVER



EROS 110X70 BLACK

ROMA

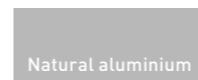

ROMA LATERAL NATURAL ALU

ROMA 3 NATURAL ALU

ROMA 3 MD NATURAL ALU

ROMA 4 NATURAL ALU

CROSS

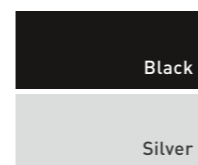

CROSS LATERAL BLACK

CROSS 4 MD BLACK

CROSS 4 BLACK

	WIDTH	LENGTH	HEIGHT	WEIGHT	MAX SIZE
RAINBOW FLAP	53 cm	53 cm	71 cm	4,2 kg	Ø 80 ; 80x80 cm
RAINBOW FLAP MD			111 cm	5,3 kg	Ø 70 ; 70x70 cm
RAINBOW FLAP LATERAL	65 cm	76 cm	71 cm	6,5 kg	110x70 ; 120x80 cm
EROS 70X70	63,5 cm	63,5 cm	72 cm	4,5 kg	70x70 cm
EROS 80X80	73,5 cm	73,5 cm		5 kg	80x80 cm
EROS 110X70	63,5 cm	103,5 cm		5,5 kg	110x70 cm
EROS 120X80	73,5 cm	113,5 cm		5,5 kg	120x80 cm

	WIDTH	LENGTH	HEIGHT	WEIGHT	MAX SIZE
ROMA 3	51 cm	51 cm	71 cm	7 kg	Ø 70 cm
ROMA 4	47 cm	47 cm		8 kg	Ø 80 ; 70x70 ; 70x60 cm
ROMA MD			108 cm	9,2 kg	Ø 70 ; 70x70 ; 70x60 cm
ROMA LATERAL	61,5 cm	72 cm	71 cm	11 kg	110x70 ; 120x80 cm
CROSS 4	40 cm	40 cm	73,5 cm	6 kg	Ø 80 ; 80x80 cm
CROSS 4 MD			115 cm	7,4 kg	Ø 70 ; 70x70 ; 70x60 cm
CROSS LATERAL	60 cm	63 cm	73,5 cm		

PENTA

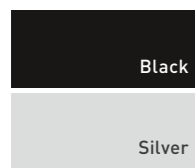

PENTA ROUND SILVER

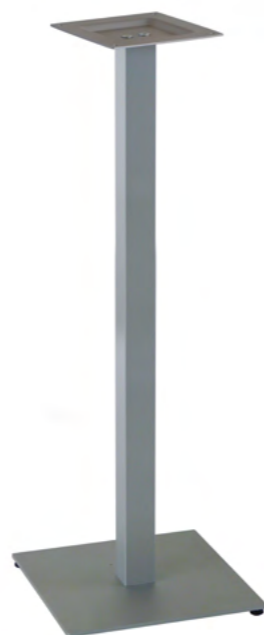

PENTA SQUARE MD SILVER



PENTA SQUARE BLACK



PENTA RECTANGLE BLACK

	WIDTH	LENGTH	HEIGHT	WEIGHT	MAX SIZE
PENTA ROUND	Ø 42 cm		72 cm	14 kg	Ø 80 ; 80x80 ; 80x60 cm
PENTA SQUARE	39 cm	39 cm	73 cm	14,5 kg	
PENTA SQUARE MD			111 cm	16 kg	Ø 70 ; 70x70 ; 70x60 cm
PENTA RECTANGLE			59 cm	72 cm	19 kg

PENTA INOX



PENTA ROUND INOX

PENTA SQUARE MD INOX



PENTA SQUARE INOX

ELIO

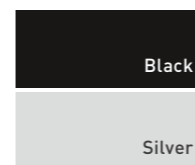

ELIO 3 SILVER



ELIO 4 BLACK

	WIDTH	LENGTH	HEIGHT	WEIGHT	MAX SIZE
PENTA ROUND	Ø 42 cm		72 cm	14 kg	Ø 80 ; 80x80 ; 80x60 cm
PENTA SQUARE	39 cm	39 cm	73 cm	14,5 kg	
PENTA SQUARE MD			111 cm	16 kg	Ø 70 ; 70x70 ; 70x60 cm
ELIO 3	56 cm	56 cm	73 cm	5 kg	Ø 80 cm
ELIO 4	47 cm	47 cm		5,5 kg	Ø 80 ; 80x80 ; 80x60 cm

TIPI

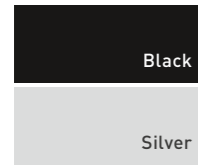

TIPI 4 BLACK



TIPI 4 SILVER



TIPI 3 FLAP BLACK

BOLOGNA



BOLOGNA 4 BLACK

ROCHELLE

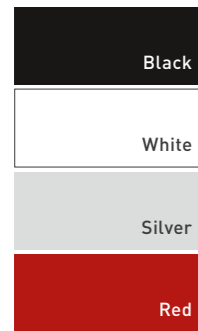

ROCHELLE 1 WHITE



ROCHELLE 1 RED



ROCHELLE 1 SILVER



ROCHELLE 1 BLACK



BOLOGNA 3 BLACK



BOLOGNA LATERAL BLACK



BOLOGNA 4 SPEC BLACK



BOLOGNA 4 MD BLACK

	WIDTH	LENGTH	HEIGHT	WEIGHT	MAX SIZE
TIPI 3	58 cm	58 cm	73 cm	6 kg	Ø 80 cm
TIPI 3 FLAP				7,5 kg	
TIPI 4	47 cm	47 cm		7 kg	Ø 80 ; 80x80 cm
TIPI 4 FLAP				8,5 kg	
ROCHELLE 1	40 cm	39 cm	71 cm	2,6 kg	Ø 80 ; 70x70 ; 100x60 cm
ROCHELLE 2		59 cm		3 kg	

	WIDTH	LENGTH	HEIGHT	WEIGHT	MAX SIZE
BOLOGNA 3	54 cm	54 cm	70 cm	4 kg	Ø 70 cm
BOLOGNA 4	44 cm	44 cm		6 kg	Ø 80 ; 80x80 ; 80x60 cm
BOLOGNA 4 MD	54 cm	54 cm	108 cm	11 kg	Ø 70 ; 70x70 ; 70x60 cm
BOLOGNA 4 SPEC	66 cm	66 cm	70 cm	10 kg	Ø 120 ; 90x90 cm
BOLOGNA LATERAL	59 cm	90 cm		9 kg	120x80 cm

	MODEL	WIDTH	LENGTH	HEIGHT	WEIGHT	FINISH	MATERIALS	MAX TOP SIZE
	AVANGARD FIXED	47 cm	51,5 cm	71 cm	6,5 kg	natural aluminium	aluminium	Ø 80 ; 80x80 ; 70x60 cm
	AVANGARD FLAP			111,5 cm	8 kg	anthracite white		Ø 80 ; 70x60 cm
	AVANGARD FLAP MD							
	AVE 4 FLAP	52 cm	52 cm	72 cm	6,2 kg	black silver	aluminium	Ø 80 ; 80x80 ; 80x60 cm
	AVE 4 MD FLAP			110 cm	6,9 kg			
	AVE LATERAL FLAP			72 cm	9,5 kg			
	BISTRO 3	41 cm	41 cm	71,5 cm	12,4 kg	black	cast iron	Ø 60 cm
	BISTRO 3 FLAP				6,5 kg			
	BISTRO 4				13,6 kg			
	BISTRO 4 MD	17,2 kg						
	BISTRO LATERAL PM	12 kg						
	BISTRO LATERAL GM	12,6 kg						
	BOLOGNA 3	54 cm	54 cm	70 cm	4 kg	black	cast aluminium	Ø 70 cm
	BOLOGNA 4	44 cm	44 cm	70 cm	6 kg			Ø 80 ; 80x80 ; 80x60 cm
	BOLOGNA 4 MD	54 cm	54 cm	108 cm	11 kg			Ø 70 ; 70x70 ; 70x60 cm
	BOLOGNA 4 SPEC	66 cm	66 cm	70 cm	10 kg			Ø 120 ; 90x90 cm
	BOLOGNA LATERAL	59 cm	90 cm	70 cm	9 kg			120x80 cm
	BOOMRANG FLAP	51,5 cm	51,5 cm	71 cm	5 kg	anthracite silver	aluminium	Ø 90 ; 90x90 cm
	BOOMRANG FLAP MD	51,5 cm	51,5 cm	111,5 cm	6,6 kg			Ø 80 ; 80x80 cm
	CONTACT X4 CLASSIC	47 cm	51,5 cm	71 cm	4,7 kg	black silver	aluminium	Ø 80 ; 80x80 ; 70x60 cm
	CONTACT X4 CLASSIC MD	47 cm	51,5 cm	110 cm	5,4 kg			Ø 70 ; 70x70 ; 70x60 cm
	CONTACT X4 DELUXE	47 cm	51,5 cm	71 cm	5,4 kg	black silver	aluminium	Ø 80 ; 80x80 ; 70x60 cm
	CONTACT X4 DELUXE MD	47 cm	51,5 cm	110 cm	6,1 kg			Ø 70 ; 70x70 ; 70x60 cm
	CONTACT X4 LUNA	Ø 53 cm		71 cm	14,5 kg	black	steel	Ø 80 ; 80x80 cm
	CONTACT X4 LUNA MD	Ø 53 cm		110 cm	15,4 kg			Ø 70 ; 70x70 cm
	CONTACT X4 T-BASE	50 cm	91,5 cm	71,5 cm	13,6 kg	black silver	steel	120x80 cm
	CONTACT X4 TRAIL	46 cm	46 cm	71 cm	6 kg	black silver	steel	Ø 80 ; 80x80 cm
	CONTACT X4 TRAIL MD	46 cm	46 cm	110 cm	7,3 kg			Ø 70 ; 70x70 cm
	CONTACT X4 STREET	46 cm	46 cm	71 cm	7,2 kg	black silver	steel	Ø 80 ; 80x80 cm
	CONTACT X4 STREET MD	46 cm	46 cm	110 cm	8,4 kg			Ø 70 ; 70x70 cm
	CROSS 4	40 cm	40 cm	73,5 cm	6 kg	black silver	aluminium steel tube	Ø 80 ; 80x80 cm
	CROSS 4 MD	40 cm	40 cm	115 cm	7,4 kg			Ø 70 ; 70x70 ; 70x60 cm
	CROSS LATERAL	60 cm	63 cm	73,5 cm	7,4 kg			120x80 cm
	ELIO 3	56 cm	56 cm	73 cm	5 kg	black silver	steel	Ø 80 cm
	ELIO 4	47 cm	47 cm	73 cm	5,5 kg			Ø 80 ; 80x80 ; 80x60 cm
	EROS 70X70	63,5 cm	63,5 cm	72 cm	4,5 kg	white black silver	aluminium	70x70 cm
	EROS 80X80	73,5 cm	73,5 cm	72 cm	5 kg			80x80 cm
	EROS 110X70	63,5 cm	103,5 cm	72 cm	5 kg			110x70 cm
	EROS 120X80	73,5 cm	113,5 cm	72 cm	5,5 kg			120x80 cm

	MODEL	WIDTH	LENGTH	HEIGHT	WEIGHT	FINISH	MATERIALS	MAX TOP SIZE
	NICE 4	40 cm	40 cm	73 cm	11,3 kg	black	cast iron	Ø 70 ; 70x70 ; 70x60 cm
	PENTA ROUND	Ø 42 cm		72 cm	14 kg	black silver	steel	Ø 80 ; 80x80 ; 80x60 cm
	PENTA SQUARE	39 cm	39 cm	73 cm	14,5 kg			Ø 80 ; 80x80 ; 80x60 cm
	PENTA SQUARE MD	39 cm	39 cm	111 cm	16 kg			Ø 70 ; 70x70 ; 70x60 cm
	PENTA RECTANGLE	39 cm	59 cm	72 cm	19 kg			120x80 cm
	PENTA INOX ROUND	Ø 42 cm		72 cm	14 kg	inox	inox	Ø 80 ; 80x80 ; 80x60 cm
	PENTA INOX SQUARE	39 cm	39 cm	73 cm	14,5 kg			Ø 80 ; 80x80 ; 80x60 cm
	PENTA INOX SQUARE MD	39 cm	39 cm	111 cm	16 kg			Ø 70 ; 70x70 ; 70x60 cm
	RAINBOW FLAP	53 cm	53 cm	71 cm	4,2 kg	inox black	aluminium	Ø 80 ; 80x80 cm
	RAINBOW FLAP MD	53 cm	53 cm	111 cm	5,3 kg			Ø 70 ; 70x70 cm
	RAINBOW FLAP LATERAL	65 cm	76 cm	71 cm	6,5 kg			110x70 ; 120x80 cm
	REFLEX 3 FLAP	52 cm	52 cm	72 cm	9 kg	anthracite silver	aluminium	Ø 70 cm
	ROCHELLE 1	40 cm	39 cm	71 cm	2,6 kg	white black silver red	steel	Ø 80 ; 70x70 ; 100x60 cm
	ROCHELLE 2	40 cm	59 cm	71 cm	3 kg			Ø 120 ; 90x90 ; 120x80 cm
	ROMA 3	51 cm	51 cm	71 cm	7 kg	natural aluminium	aluminium	Ø 70 cm
	ROMA 4	47 cm	47 cm	71 cm	8 kg			Ø 80 ; 70x70 ; 70x60 cm
	ROMA MD	47 cm	47 cm	108 cm	9,2 kg			Ø 70 ; 70x70 ; 70x60 cm
	ROMA LATERAL	61,5 cm	72 cm	71 cm	11 kg			110x70 ; 120x80 cm
	RONDA 42 TB	Ø 42 cm		42,5 cm	14 kg	black	steel	Ø 80 ; 80x80 ; 80x60 cm
	RONDA 42	Ø 42 cm		72 cm	14 kg			Ø 80 ; 80x80 ; 80x60 cm
	RONDA 42 MD	Ø 42 cm		108 cm	18 kg			Ø 70 ; 70x70 ; 70x60 cm
	RONDA 55	Ø 55 cm		72 cm	23 kg			Ø 120 ; 90x90 ; 110x70 cm
	RONDA 55 MD	Ø 55 cm		108 cm	24 kg			Ø 90 ; 80x80 cm
	TIPI 3	58 cm	58 cm	73 cm	6 kg	black silver	steel	Ø 80 cm
	TIPI 3 FLAP	58 cm	58 cm	73 cm	7,5 kg			Ø 80 cm
	TIPI 4	47 cm	47 cm	73 cm	7 kg			Ø 80 ; 80x80 cm
	TIPI 4 FLAP	47 cm	47 cm	73 cm	8,5 kg			Ø 80 ; 80x80 cm
	TYA 4	46 cm	46 cm	71 cm	2,4 kg	black silver	aluminium	Ø 70 ; 70x70 cm
	TYA 4 FLAP	46 cm	46 cm	71 cm	2,4 kg			Ø 70 ; 70x70 cm
	TYA MD	46 cm	46 cm	114 cm	2,7 kg			Ø 70 ; 70x70 cm
	TYA MD FLAP	46 cm	46 cm	114 cm	2,7 kg			Ø 70 ; 70x70 cm
	TYA LATERAL	62 cm	72 cm	71 cm	3,6 kg			110x70 ; 120x80 cm
	TYA LATERAL FLAP	62 cm	72 cm	71 cm	3,6 kg			110x70 ; 120x80 cm
	VÉSUIVE SQUARE	43 cm	43 cm	72 cm	16 kg	black	cast iron	Ø 80 ; 80x80 ; 80x60 cm
	VÉSUIVE SQUARE MD	43 cm	43 cm	108 cm	16,5 kg			Ø 70 ; 70x70 ; 70x60 cm
	VÉSUIVE ROUND	Ø 43 cm		72 cm	15 kg			Ø 80 ; 80x80 cm
	VÉSUIVE ROUND MD	Ø 43 cm		108 cm	15,5 kg			Ø 70 ; 70x70 ; 70x60 cm
	VÉSUIVE RECTANGLE	40 cm	55 cm	73 cm	19,3 kg			120x80 cm



werzalit®
since 1923.

CHAIRS & ARMCHAIRS

Werzalit offers you a selection of armchairs and chairs, complete and of high quality, to match with your tables. Comfortable and stylish, our seats range will allow you to host your customers in the best conditions. Practical to store and to move, they will allow you to arrange your rooms and terraces as you wish.



MONTMARTRE



CHAIR MONTMARTRE
ALU TUBE BAMBOO

W	46 cm
D	56 cm
H	88 cm
W	4 kg



Information



stackable



foldable

PARIS

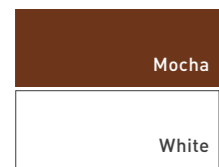

ARMCHAIR PARIS
BAMBOO WHITE

W	56,5 cm
D	53 cm
H	90 cm
W	4,9 kg



CHAIR PARIS
BAMBOO WHITE

W	42 cm
D	53 cm
H	90 cm
W	3,8 kg



CHANTILLY



CHAIR CHANTILLY
ALU TUBE BAMBOO

W	47 cm
D	61 cm
H	94 cm
W	4 kg



VINCENNES



CHAIR VINCENNES
ALU TUBE BAMBOO

W	49 cm
D	58 cm
H	88 cm
S	46 cm
W	4 kg



Also available in the GOURMET kit page 69

KIT

Also available in the BISTRO 1 & 2 kits page 69

KIT

TROCADERO



ARMCHAIR PARIS
BAMBOO MOCHA

W	56,5 cm
D	53 cm
H	90 cm
W	4,9 kg



CHAIR PARIS
BAMBOO MOCHA

W	42 cm
D	53 cm
H	90 cm
W	3,8 kg



ARMCHAIR TROCADERO
POLYPROPYLENE BLACK

W	46 cm
D	53 cm
H	80 cm
W	3,5 kg



ARMCHAIR TROCADERO
POLYPROPYLENE BLACK

W	46 cm
D	53 cm
H	80 cm
W	3,5 kg



RIMINI



ARMCHAIR RIMINI ANTHRACITE

W	56 cm
D	52 cm
H	80 cm
S	45,5 kg
W	5,1 kg



CHAIR RIMINI RED

W	48 cm
D	52 cm
H	80 cm
S	45,5 kg
W	3,8 kg



PRAGUE



CHAIR PRAGUE ALU TUBE ANTHRACITE SLING ANTHRACITE

W	53 cm
D	54 cm
H	78 cm
W	3,5 kg



ARMCHAIR PRAGUE ALU TUBE ANTHRACITE SLING ANTHRACITE

W	59 cm
D	57 cm
H	78 cm
W	4,2 kg



STOOL PRAGUE ALU TUBE ANTHRACITE SLING ANTHRACITE

W	57 cm
D	57 cm
H	113 cm
W	4,5 kg

SORRISO



ARMCHAIR SORRISSO WHITE

W	55 cm
D	55 cm
H	79 cm
S	45 kg
W	3,8 kg



STRASBOURG



ARMCHAIR STRASBOURG WOVEN ANTHRACITE

W	57 cm
D	59 cm
H	79 cm
S	45 kg
W	3,2 kg



ZAGREB



ARMCHAIR ZAGREB DARK BROWN ALU TUBE ANTHRACITE SLING DARK BROWN

W	55 cm
D	59 cm
H	80 cm
W	5 kg



PALERME



ARMCHAIR PALERME KARIN TAUPE ALU TUBE ANTHRACITE SLING TAUPE CUSHION TAUPE

W	59 cm
D	59 cm
H	82 cm
W	5 kg



TOKYO



ARMCHAIR TOKYO BLACK BATYLINE BLACK 5005

W	57 cm
D	54 cm
H	84 cm
S	45 kg
W	4,2 kg



ARMCHAIR TOKYO BLACK BATYLINE TAUPE 5014

W	57 cm
D	54 cm
H	84 cm
S	45 kg
W	4,2 kg



CHAIR TOKYO BLACK BATYLINE BLACK 5005

W	43 cm
D	48,5 cm
H	84 cm
S	45 kg
W	3,5 kg



TOSCANA



ARMCHAIR TOSCANA ANTHRACITE 5X5

W	56 cm
D	55 cm
H	86 cm
S	66 kg
W	5,5 kg



CHAIR TOSCANA ANTHRACITE 5X5

W	44 cm
D	55 cm
H	88 cm
W	4 kg



HAVANA



CHAIR HAVANA
ALU TUBE BAMBOO LOOK
SLING BEIGE

W	59 cm
D	61 cm
H	83 cm
W	3,5 kg



ARMCHAIR HAVANA
ALU TUBE BAMBOO LOOK
SLING BEIGE

W	59 cm
D	61 cm
H	83 cm
W	3,5 kg



KROMY

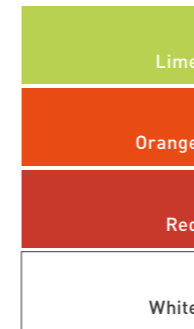

CHAIR KROMY
RED

W	46 cm
D	53 cm
H	80 cm
W	3,5 kg



BALI



CHAIR BALI
COFFEE

W	41,5 cm
D	52 cm
H	83 cm
S	43,5 kg
W	3,4 kg



ARMCHAIR BALI
COFFEE

W	50 cm
D	51 cm
H	83 cm
S	44,5 kg
W	3,8 kg



KROMY 2

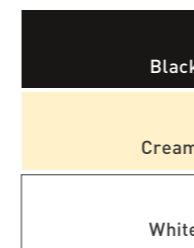

CHAIR KROMY 2
BLACK

W	44 cm
D	50 cm
H	81 cm
S	45 kg
W	3,3 kg



ARMCHAIR KROMY 2
WHITE

W	53 cm
D	62 cm
H	82 cm
S	45 kg
W	4 kg



YACHT

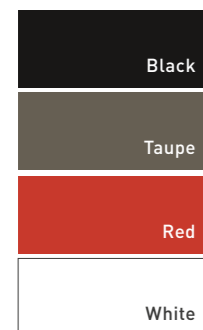

ARMCHAIR YACHT SILVER
BATYLINE BLACK 5005

W	53 cm
D	54 cm
H	78 cm
W	3,5 kg



PULZ

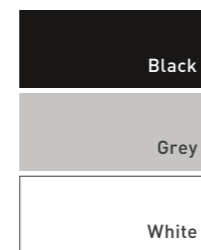

CHAIR PULZ BLACK

W	48 cm
D	54 cm
H	82 cm
S	46 cm
W	3,8 kg



KING

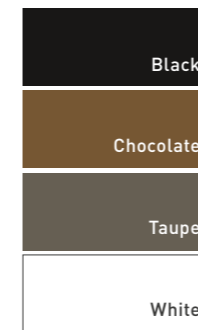















ARMCHAIR KING
BLACK

W	60 cm
D	54 cm
H	82 cm
S	45 kg
W	3,8 kg



TECHNICAL INFORMATION

			L	p	H	A	PDS	COLORIS	RANGEMENT	MATÉRIAUX
BALI	armchair		50 cm	51 cm	83 cm	44,5 cm	3,8 kg	coffee	stackable	aluminium tube
	chair		41,5 cm	52 cm	83 cm	43,5 cm	3,4 kg			
CHANTILLY	chair		47 cm	61 cm	94 cm	-	4 kg	white	stackable	aluminium tube
HAVANA	chair		59 cm	61 cm	83 cm	-	3,5 kg	bamboo tube	stackable	aluminium tube
	armchair						3,8 kg			
KING	armchair		60 cm	54 cm	82 cm	45 cm	3,8 kg	white chocolate black taupe	stackable	polypropylene
KROMY	chair		46 cm	53 cm	80 cm	-	3,5 kg	white lime orange red	stackable	polypropylene
KROMY 2	armchair		53 cm	62 cm	82 cm	45 cm	4 kg	white cream black	stackable	polypropylene
	chair		44 cm	50 cm	81 cm	45 cm	3,3 kg			
MONTMARTRE	chair		46 cm	56 cm	88 cm	-	4 kg	blue green pink	stackable	aluminium tube
PALERME	armchair		59 cm	59 cm	82 cm	-	5 kg	anthracite tube	stackable	aluminium tube
								sling taupe		
PARIS	armchair		56,5 cm	53 cm	90 cm	-	4,9 kg	bamboo white	stackable	aluminium tube
	chair		42 cm	53 cm	90 cm	-	3,8 kg	bamboo mocha		
PRAGUE	chair		53 cm	54 cm	78 cm	-	3,5 kg	anthracite	stackable	tube aluminium
	armchair		59 cm	57 cm	78 cm	-	4,2 kg			
	stool		57 cm	57 cm	113 cm	-	4,5 kg			

			L	p	H	A	PDS	COLORIS	RANGEMENT	MATÉRIAUX
PULZ	chair		48 cm	54 cm	82 cm	46 cm	3,8 kg	black grey white	stackable	polypropylene
RIMINI	armchair		56 cm	52 cm	80 cm	45,5 cm	5,1 kg	anthracite red olive	stackable	polypropylene
	chair		48 cm							
SORRISO	armchair		55 cm	55 cm	79 cm	45 cm	3,8 kg	white	stackable	polypropylene
STRASBOURG	armchair		57 cm	59 cm	79 cm	45 cm	3,2 kg	woven anthracite	stackable	aluminium tube
TOKYO	armchair		57 cm	54 cm	84 cm	45 cm	4,2 kg	white black red taupe	stackable	aluminium tube
	chair		43 cm	48,5 cm	84 cm	45 cm	3,5 kg			
TOSCANA	armchair		56 cm	55 cm	86 cm	66 cm	5,5 kg	anthracite	stackable	aluminium tube
	chair		44 cm	55 cm	88 cm	-	4 kg			
TROCADERO	armchair		46 cm	53 cm	80 cm	-	3,5 kg	black	stackable	polypropylene
	armchair									
VINCENNES	chair		49 cm	58 cm	88 cm	46 cm	4 kg	black	stackable	aluminium tube
YACHT	armchair		57 cm	51 cm	89 cm	66 cm	4,4 kg	black red taupe	foldable	aluminium tube
ZAGREB	armchair		55 cm	59 cm	80 cm	-	5 kg	anthracite tube sling dark brown	stackable	aluminium tube



TABLES & KITS

Being aware of the challenges of your business, Werzalit goes beyond its status of French manufacturer of tabletops and is deploying new solutions to provide you even more support. For this, we imagined ready-to-install Kits. Cost-effective solutions that matches your most urgent needs. Thanks to the Kit solution, enjoy a shipment within 72 hours and benefit from a simplified set-up and a quick installation with this winning combination.

Kit n°1
BISTRO

Offer
380€
excluding VAT

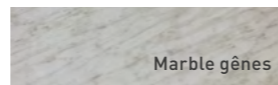

Ø 60 tabletop
Marble gènes
with brass strapping and inserts



Bistro 3 black base



2 Paris Bamboo mocha chairs

WHAT YOU NEED:



15 min 1 pers.

Kit n°3
MASSIVE

Offer
295€
excluding VAT

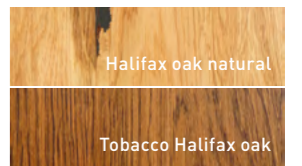

70 x 70 tabletop
Halifax oak natural/Tobacco
Halifax oak
with inserts



square Penta black base

WHAT YOU NEED:



15 min 1 pers.

Kit n°2
BISTRO 2

Offer
360€
excluding VAT

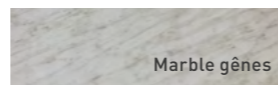

70 x 70 tabletop
Marble Gènes
with inserts



Bistro 4 black base



2 Paris Bamboo mocha armchairs

WHAT YOU NEED:



15 min 1 pers.

Kit n°4
INDOOR ROCK

Offer
230€
excluding VAT

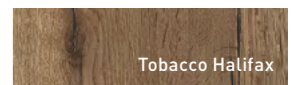

65 x 65 tabletop
(21 mm / 29 mm / 39 mm)
Synchro Tobacco Halifax
with inserts



CONTACT X4 Street black base

WHAT YOU NEED:



15 min 1 pers.

Kit n°5
OUTDOOR ROCK

Offer
560€
excluding VAT



- 70 x 70 tabletop
Kentucky
with inserts
- +
- CONTACT X4 Deluxe** silver base
- +
- 2 **Palerme** taupe armchairs

WHAT YOU NEED:



Kit n°7
IPAN IPAN

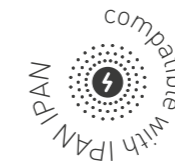

Offer
350€
excluding VAT



- 70 x 70 tabletop
Georgia
Ipan Ipan option
(wireless charging) with inserts
- +
- CONTACT X4 Deluxe** black base

WHAT YOU NEED:



Kit n°6
SEASIDE

Offer
300€
excluding VAT



- 70 x 70 tabletop
Palissade white / Marble gênes
with inserts
- +
- Avangard** natural aluminium base

WHAT YOU NEED:



Kit n°8
GOURMET

Offer
430€
excluding VAT



- 55 x 55 tabletop
Marble sienna
with brass frame and inserts
- +
- Bistro 3** black base
- +
- 2 **Paris bamboo** white chairs

WHAT YOU NEED:



Universal

Universal trolley for storage and folding table bases.

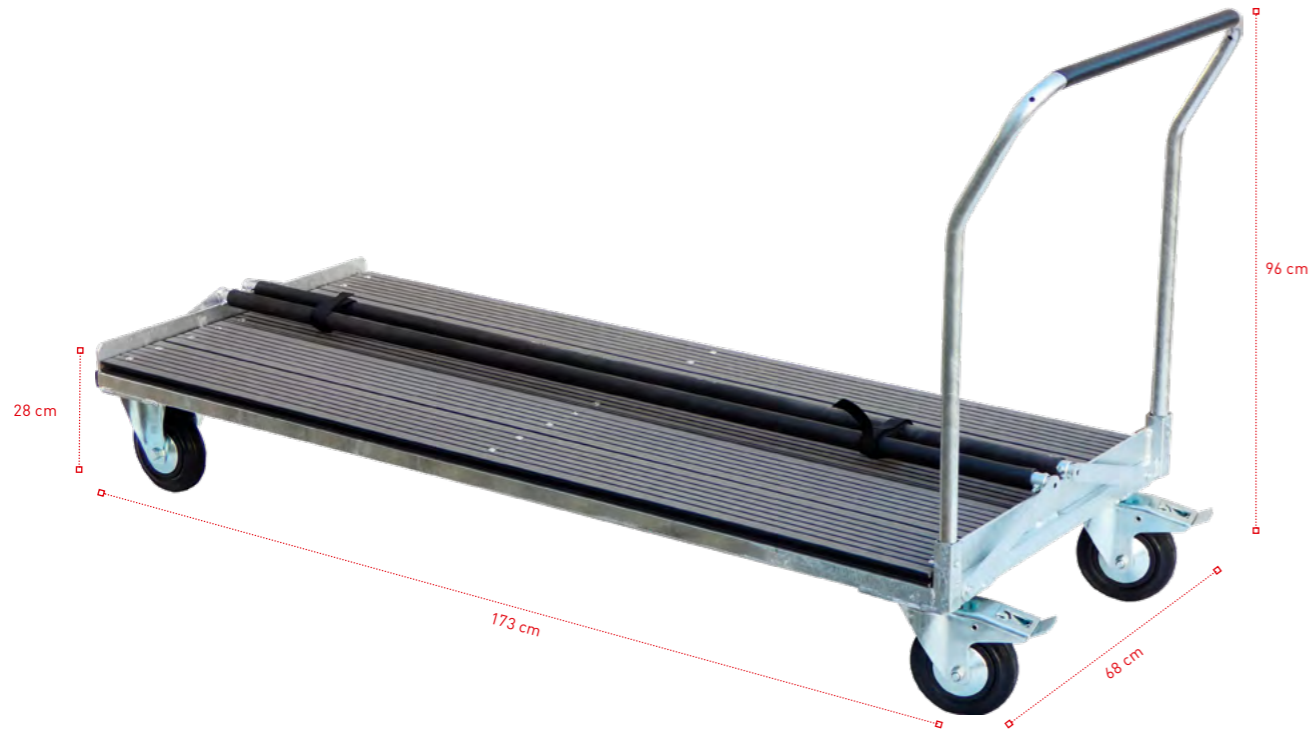

POS



POS 5 TABLETOPS

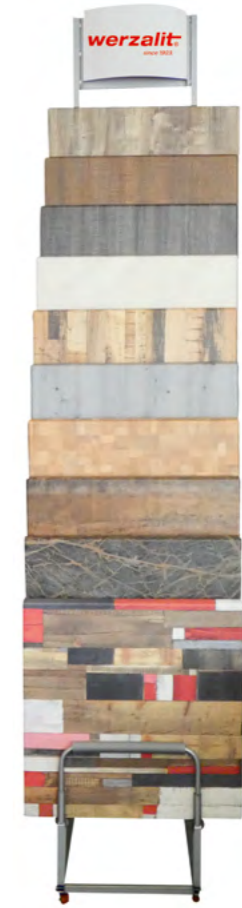

POS 10 TABLETOPS



11 X AVANGARD



10 X BOOMRANG



8 X DELUXE



9 X REFLEX 3



POS 20 1/4 TOPS



POS 40 1/4 TOPS



werzalit®
since 1923.

ECOLINE

Werzalit introduces its Gentas Ecoline collection, qualitative products at a lower cost. The goal of these products is to allow our customers on the tightest budgets to equip their terraces and indoor rooms with specific tabletops.

HPL by
Gentas

Gentas compact tabletops are the economical and aesthetic solution for your terraces or indoor rooms. Benefit from a two-year warranty on all these products. HPL by Gentas are 12mm thick.

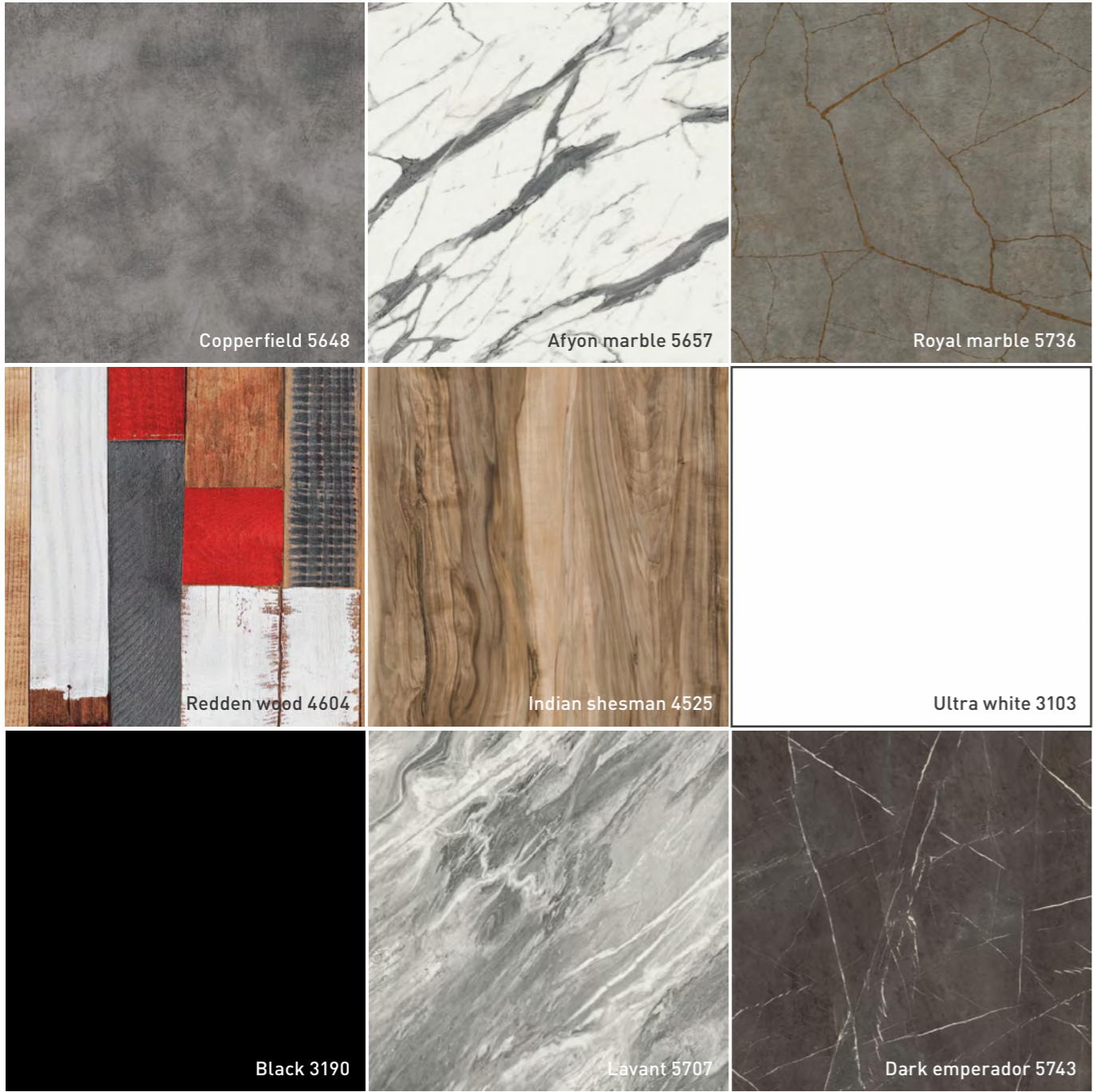

○ ROUND		□ SQUARE		
Ø 60	Ø 69	60x60	69x69	80x80
•	•	•	•	•

Werzalit by
Gentas

With Werzalit by Gentas tops, enjoy the charm and authenticity of moulded laminate tabletops at a lower cost. Benefit from a two-year warranty on all Werzalit by Gentas tabletops.

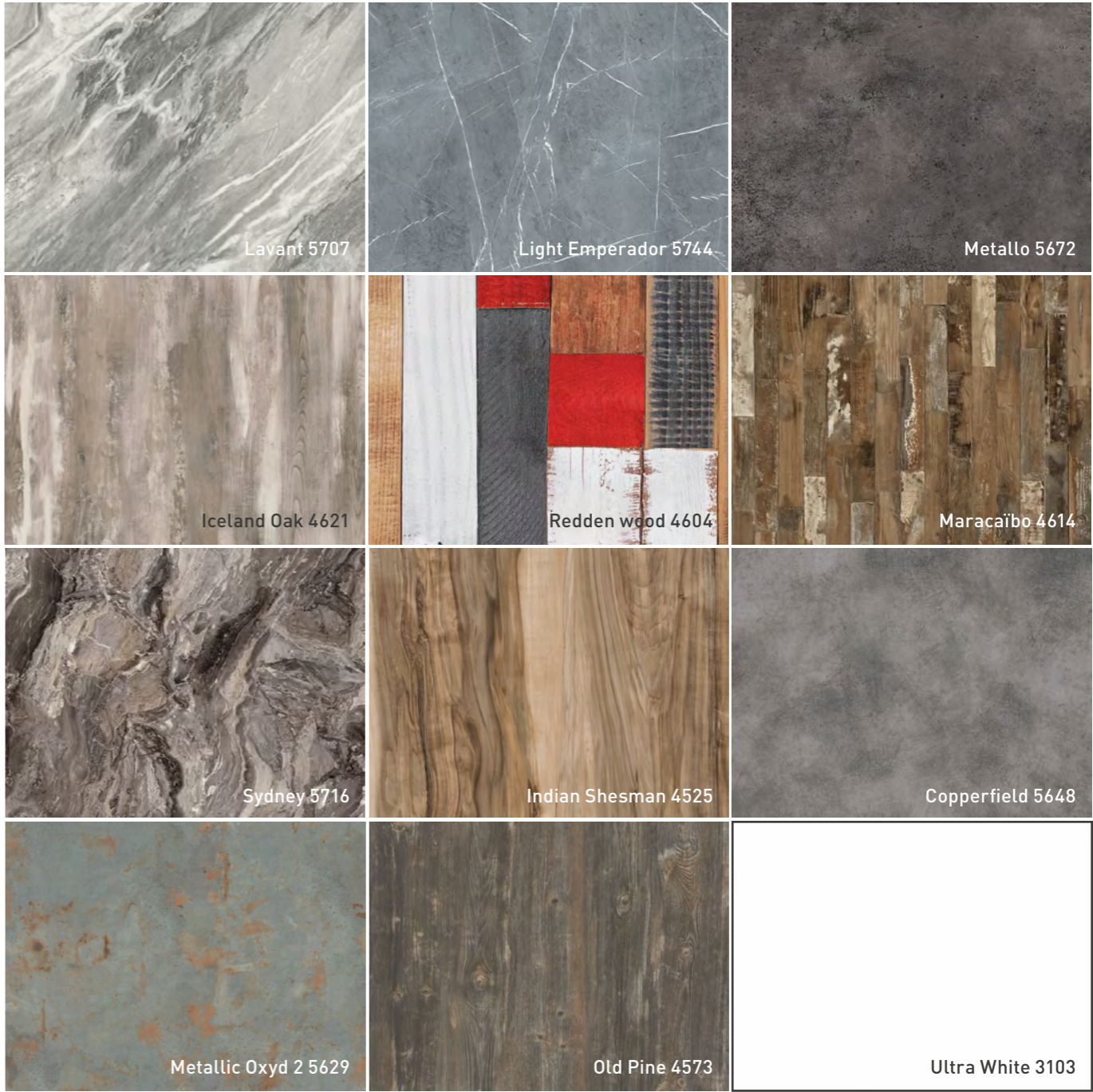

○ ROUND			□ SQUARE			▭ RECTANGLE	
Ø 60	Ø 70	Ø 80	60x60	70x70	80x80	110x70	120x80
•	•	•	•	•	•	•	•

NOTES

A large grid of small dots for taking notes, covering the majority of the page.

werzalit®

since 1923.

WERZALIT®, it is more than 60 years of passion for the manufacture of moulded laminate tops.

Beyond proudly claiming our status as a manufacturer, it is the WERZALIT® brand that shines all over the world with a very wide range, quality products, meticulous finishes, and constantly renewed designs.

WERZALIT

Avenue des Bois Déroulés - 17308 Rochefort-sur-Mer Cedex - France

Tél : +33 (0)5 46 82 15 40

<http://www.werzalit.com> - Email : commercial.fr@werzalit.com